





# *vdi*\_rack®



Video



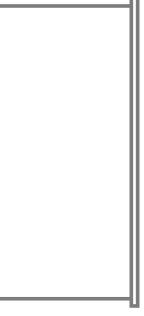
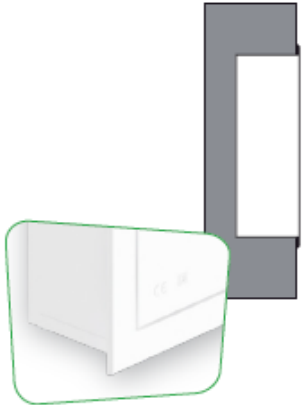
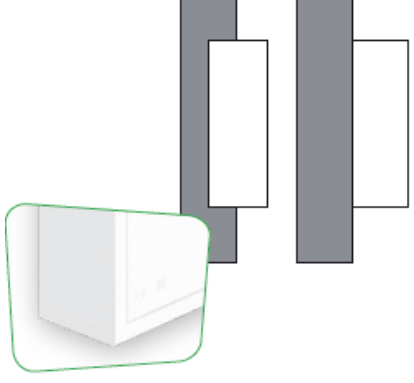



| <b>PROFUNDIDADE</b><br><b>DEPTH</b><br><b>PROFONDEUR</b><br><b>PROFUNDIDAD</b><br><b>عمق</b> | <br>90mm                         |             |             | <br>125mm                          |             |             | <br>200mm |  |  |
|----------------------------------------------------------------------------------------------|-------------------------------------------------------------------------------------------------------------------|-------------|-------------|---------------------------------------------------------------------------------------------------------------------|-------------|-------------|----------------------------------------------------------------------------------------------|--|--|
| <b>INSTALAÇÃO</b><br><b>INSTALLATION</b><br><b>INSTALACIÓN</b><br><b>التركيب</b>             | <br>INT   FM   ENC   EMP   مدمج |             |             | <br>EXT   SM   AAP   SUP   نتوء |             |             |                                                                                              |  |  |
| <b>COD</b><br><b>P90 /D90mm</b>                                                              | 00096530                                                                                                          | 00096532    | 00096534    | 00096531                                                                                                            | 00096533    | 00096535    |                                                                                              |  |  |
| <b>DIM</b>                                                                                   | 250x375x90                                                                                                        | 400x375x90  | 400x500x90  | 250x375x90                                                                                                          | 400x375x90  | 400x500x90  |                                                                                              |  |  |
| <b>COD</b><br><b>P125 /D125mm</b>                                                            | 00096538                                                                                                          | 00096540    | 00096542    | 00096539                                                                                                            | 00096541    | 00096543    |                                                                                              |  |  |
| <b>DIM</b>                                                                                   | 400x375x125                                                                                                       | 400x500x125 | 400x750x125 | 400x375x125                                                                                                         | 400x500x125 | 400x750x125 |                                                                                              |  |  |
| <b>COD</b><br><b>P200 /D200mm</b>                                                            | 00096544                                                                                                          | 00096546    | 00096548    | 00096545                                                                                                            | 00096547    | 00096549    |                                                                                              |  |  |
| <b>DIM</b>                                                                                   | 400x375x200                                                                                                       | 400x500x200 | 400x750x200 | 400x375x200                                                                                                         | 400x500x200 | 400x750x200 |                                                                                              |  |  |

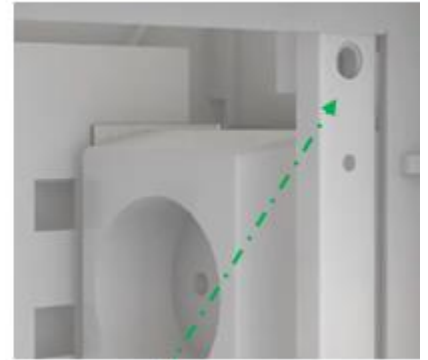
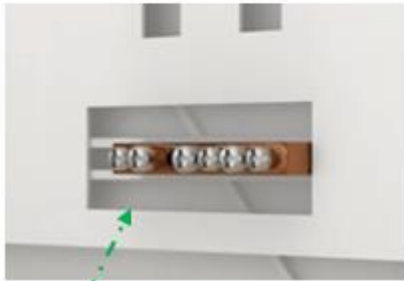

- Invólucro para instalação em paredes não combustíveis. Não deve ser instalado em locais excessivamente sujeitos a vapores corrosivos, campos magnéticos de forte valor e locais de atmosferas sujeitas a explosões, incêndios, vibrações ou choques.
- Enclosure to be installed in non-combustible walls. It should not be installed in places with corrosive substances, electromagnetic interference, abnormal technical voltages and atmospheres with explosions, fires, vibrations or shocks.
- Coffret pour installation en murs non combustibles. Ne doit pas être installé dans un lieu excessivement susceptible à vapeurs corrosives, températures extrêmes, champs magnétiques de grande valeur et lieux d'atmosphères sujet à explosions, incendies, vibrations ou chocs.
- Envoltente para instalación en paredes no combustibles. No debe ser instalado en locales excesivamente sujetos a agresiones químicas, temperaturas extremas, campos magnéticos de fuerte valor y locales de atmosferas sujetas a explosiones, incendios, vibraciones o choques.
- عربي: يجب تركيب العلب في جدران غير قابلة للاشتعال. يجب ألا يتم تركيب العلب في مكان يحتوي على بخار مذيّب أو درجات حرارة قصوى أو حقل مغناطيسي بنسب عالية أو أماكن ذات جوّ قابل للانفجار أو الحرائق أو الاهتزاز أو الصدمات.

MONTAGEM | ASSEMBLY | MONTAGE | MONTAJE | عربي - التركيب

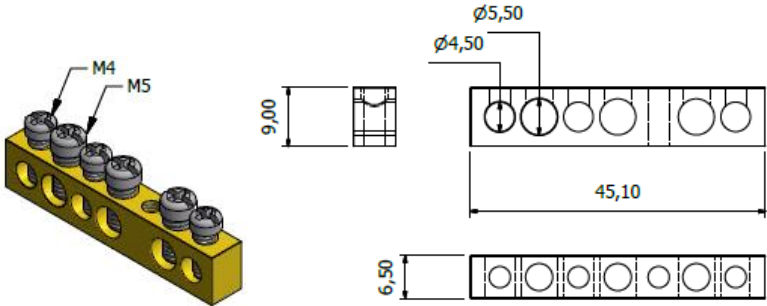
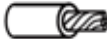

|                                                                                   |            |           |           |                                                                                   |                                                                                     |                                                                                     |                                                                                     |
|-----------------------------------------------------------------------------------|------------|-----------|-----------|-----------------------------------------------------------------------------------|-------------------------------------------------------------------------------------|-------------------------------------------------------------------------------------|-------------------------------------------------------------------------------------|
|  | <b>GWT</b> | <b>IP</b> | <b>IK</b> |  |  |  |  |
| EN (IEC) 62208                                                                    | 650°C      | 42        | 07        | 200 kg /m <sup>3</sup><br>3م/كغ                                                   | Máx 40°C<br>Min -5°C                                                                | Máx<br>50% a 40°C                                                                   | Máx 55°C<br>Min -15°C                                                               |

**BARRAMENTOS | BUSBAR | BORNIERES | EMBARRADOS | المَعْلَم**

|                                                                                   |                                                                                                                                    |                                                                                                                                   |
|-----------------------------------------------------------------------------------|------------------------------------------------------------------------------------------------------------------------------------|-----------------------------------------------------------------------------------------------------------------------------------|
|  |  <p>3x10mm<sup>2</sup> + 3x16mm<sup>2</sup></p> |  <p>3x6mm<sup>2</sup> + 3x10mm<sup>2</sup></p> |
|-----------------------------------------------------------------------------------|------------------------------------------------------------------------------------------------------------------------------------|-----------------------------------------------------------------------------------------------------------------------------------|

**ACESSÓRIOS | ACCESSORIES | ACCESSOIRES | ACCESORIOS | مستلزمات**

**UNIÃO DE CAIXAS | GROUPING ENCLOSURES | UNIÓN DE ENVOLVENTES | UNION DE COFRETS | وحدة العلب**

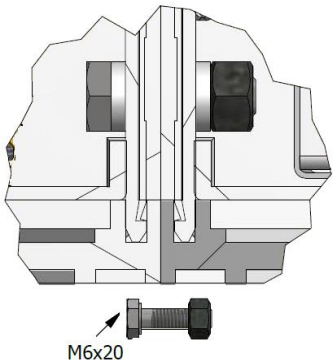
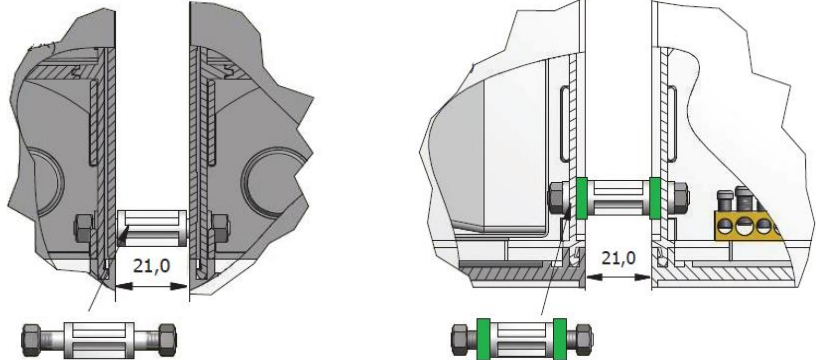
|                                                                                                                                                                                      |                                                                                                                                                                                                                                                 |
|--------------------------------------------------------------------------------------------------------------------------------------------------------------------------------------|-------------------------------------------------------------------------------------------------------------------------------------------------------------------------------------------------------------------------------------------------|
| <p>SALIENTE   SURFACE MOUNTED   APPARENTE<br/>SALIENTE   السطح المركبة<br/><b>COD. 00226</b></p>  | <p>EMBUTIR   FLUSH MOUNTED   ENCASTRÉE   EMPOTRADA   دافق شنت<br/><b>COD. 00225</b></p> <p>PROF.   DEPTH   عمق → 90mm      PROF.   DEPTH   عمق → 125mm</p>  |
|--------------------------------------------------------------------------------------------------------------------------------------------------------------------------------------|-------------------------------------------------------------------------------------------------------------------------------------------------------------------------------------------------------------------------------------------------|

REFORÇO RESISTÊNCIA MECÂNICA  
METALLIC REINFORCEMENT KIT  
RENFORCEMENT DE LA RÉSISTANCE MÉCANIQUE  
REFUERZO DE LA RESISTENCIA MECÁNICA

PROF. | DEPTH | عمق → 125 mm

**COD. 0022012 – 0022082**



Video